



WE MAGNETISE THE WORLD



System Line

AC Single-Stroke Solenoids



INDUSTRIAL MAGNETIC SYSTEMS

BINDER

We develop solutions!

Kendrion develops, manufactures and markets high-quality electromagnetic and mechatronic systems and components for industrial and automotive applications. For over a century we have been engineering precision parts for the world's leading innovators in passenger cars, commercial vehicles and industrial applications.

As a leading technology pioneer, Kendrion invents, designs and manufactures complex components and customised systems as well as local solutions on demand. Committed to the engineering challenges of tomorrow, taking responsibility for how we source, manufacture and conduct business is embedded into our culture of innovation. Rooted in Germany and headquartered in the Netherlands, our expertise extends across Europe to the Americas and Asia. Created with passion and engineered with precision.

In the business unit **Industrial Magnetic Systems (IMS)** the focus lies on electromagnetic actuators and mechatronic assemblies for applications in power engineering, safety engineering, machine building, automation technology and other industries. With the experience of our traditional brands Binder, Neue Hahn Magnet and Thoma Magnettechnik we are successful in our markets as an industry expert with a high technological competence.

We offer you both customer-specific and standardised products. Our assemblies are based on powerful and reliable single-stroke, holding, locking, spreader, control, rotary, vibratory solenoids and solenoid valves.

We always think in terms of solutions.

Our strength lies in new developments for our customers. Our engineers are specialists for innovative products with optimum technical properties. Furthermore, we develop mechanical assemblies, modern drive electronics and sensor systems to your requirements.

Our products are manufactured in Germany at the parent companies Donaueschingen and Engelswies as well as in the USA, China and Romania. This ensures efficient project management and a needs-oriented delivery for our internationally operating customers.

By means of segmented production areas we can implement both small quantities and large series with an optimum degree of automation.

We guarantee top quality.

All products are tested and developed in compliance with the norm DIN VDE 0580 for electromagnetic devices and components or according to industry-specific standards of our customers. In many cases our products are tested and certified by external associations, among others according to the CSA, VdS and ATEX guidelines. Our quality management system is certified according to DIN EN ISO 9001, and our environmental management system fulfils the norm ISO 14001.

With our subsidiaries in Switzerland, Austria, Italy, the USA, China and our worldwide distribution network we are your ideal partner on site.

Kendrion – We magnetise the world

www.kendrion.com



System Line - AC Single-Stroke Solenoids

The AC single-stroke solenoids of the Kendrion „System Line“ are manufactured from magnetically high-quality sheet metals.

This design evokes a dynamic force behaviour, the maximum force being reached at the stroke end position. Due to this ascending force characteristic AC single-stroke solenoids are particularly suitable for overcoming spring forces. Compared to the DC single-stroke solenoid higher switching capacities are possible as the switching times are considerably shorter here. In addition, AC single-stroke solenoids with the same performance have a smaller design as the power consumption during the stroke travel is variable (descending).

It has to be ensured that the armature can pull up until it completely rests on the pole faces as otherwise a thermal overload of the coil may lead to failure.

Due to these special attributes the components are used in machine building, plant construction and switchgear manufacturing as well as in textile, office and packaging technology.

The stroke movement takes place from the stroke starting position to the stroke end position (active direction of movement), while the armature reset is accomplished by external forces such as spring or weight force. The armature reset is to be accomplished by the customer.

The magnetic forces indicated are reached at 90% of the nominal voltage and in warmed-up condition. The values of the duty cycles apply for nominal voltage, warmed-up condition and load with 70% of the magnetic force of the device.

All products are manufactured and tested according to DIN VDE 0580/07.2000.
Design subject to change.

AC Solenoids Series WL

With the AC solenoids of the **series WL** the yoke is Ushaped while the armature is T-shaped, the pole faces remain blank after grinding in. This design allows for optimum pulling force results with relatively small sizes as the lines of force can pass the working air gap either in the coil centre or via the limbs.



The solenoid system can be used for short as well as longer strokes (max. 50 mm).

On request further sizes and coil designs are available. With respect to the coil design higher forces can be achieved under consideration of a shorter duty cycle. Pushing models are also available on request. Here it has to be ensured that the force transfer is achieved by a non-magnetic stud.

Model

- 01, pulling with pull rod
- 04, pushing, with bore, without pull rod, without push shaft (on request)

Preferred Voltage

- 230 V / 50 Hz

Protection Class

- IP00

Accessories

- Mechanical stroke limitation (only for types WL230 and WL330 available)
- Forc joint DIN 71751

EC Guidelines

- EC Machine guideline 2006/42/EC

Norms and Regulations

- Protection classes by housing VDE 0580
- Insulation class B 130 VDE 0580/07.2000
- Electromagnetic devices and components EN 60529

Key for Type Designation and Order Example

WL 230 01

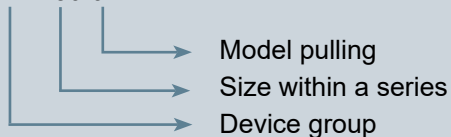

WL23001

Model pulling
230V, 50Hz, 100% duty cycle, 20mm stroke,
27 N stroke force

Cross Section

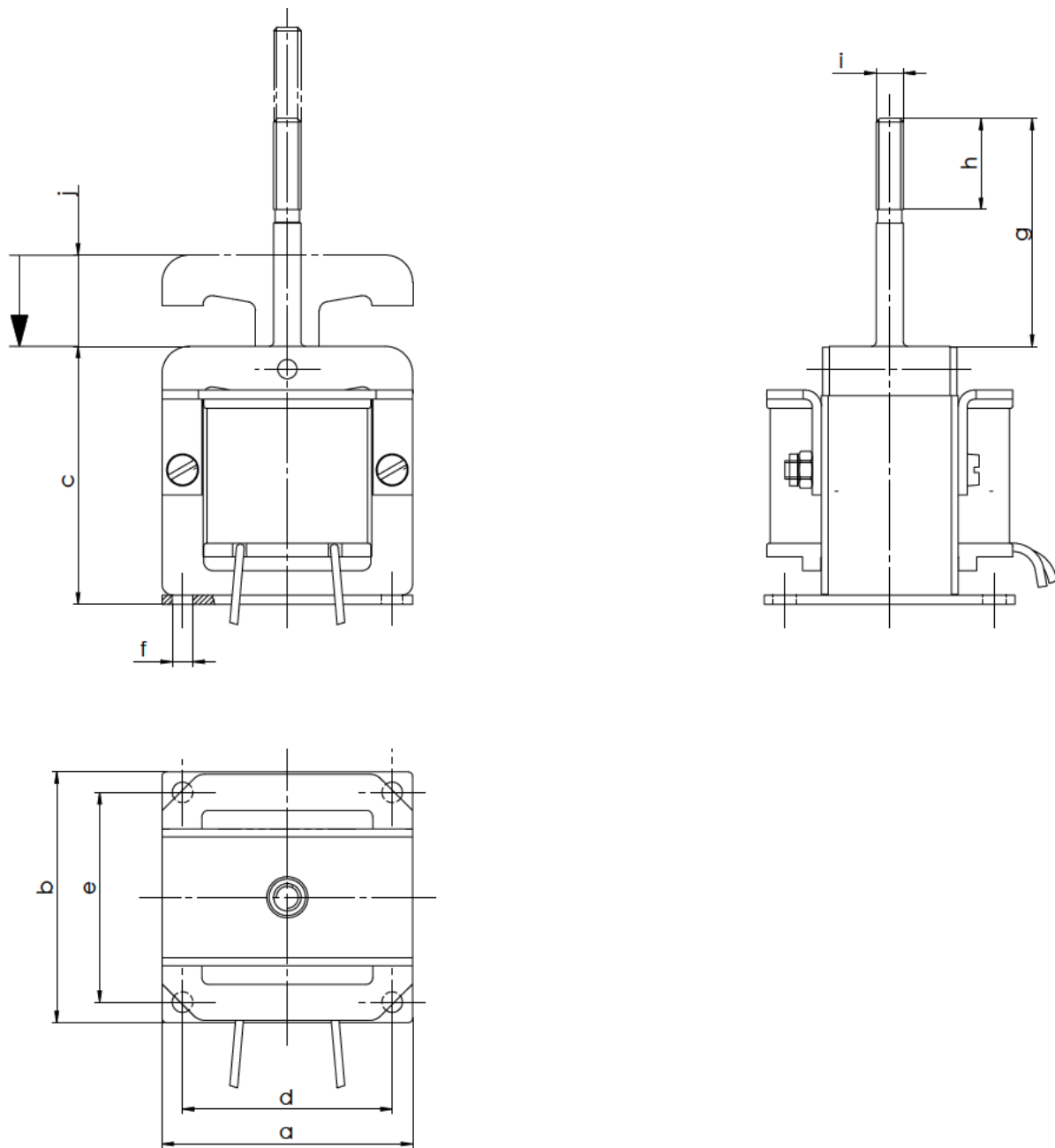

Dimensions in mm

Type	a	b	c	d	e	f	g	h	i	j
WL125	46	42	50.6	36	35	Ø3.5	50	20	M6	20
WL230	55	55	56.6	46	46	Ø4.5	50	20	M6	20
WL330	72	66	64.6	62	54	Ø5.5	60	20	M8	25

Technical Data

Type	WL125	WL230	WL330
Stroke (mm)	20	20	25
Duty cycle (%)	100	100	100
Initial force (N)	7	27	55
Appar. power stroke start (KVA)	0.430	1.000	1.700
End force (N)	51	102	133
Apparent power stroke end (KVA)	0.048	0.070	0.100
Pull-in time (ms) max. stroke	65	65	72
Release time (ms) max. stroke	65	65	72
Weight solenoid in kg	approx. 0,5	approx. 0.8	approx. 1.3
Weight armature in kg	approx. 0,14	approx. 0.22	approx. 0.35

Switching Frequency

Type	Stroke 0		Stroke 2		Stroke 4		Stroke 6		Stroke 8		Stroke 10		Stroke 15		Stroke 20		Stroke 25	
	N	KVA	N	KVA	N	KVA	N	KVA	N	KVA	N	KVA	N	KVA	N	KVA	N	KVA
WL125	51	0.048	51	0.170	41	0.250	30	0.300	23	0.340	18	0.360	13	0.400	7	0.430	-	-
WL230	102	0.070	102	0.300	74	0.410	59	0.500	52	0.610	49	0.700	40	0.850	27	1.000	-	-
WL330	133	0.100	133	0.350	113	0.530	88	0.650	78	0.750	73	0.870	68	1.200	66	1.500	55	1.700

Highest switching frequency per hour (S/h) with design 100% Duty Cycle

3600

1200

600

300

Stroke Force Characteristic Curves

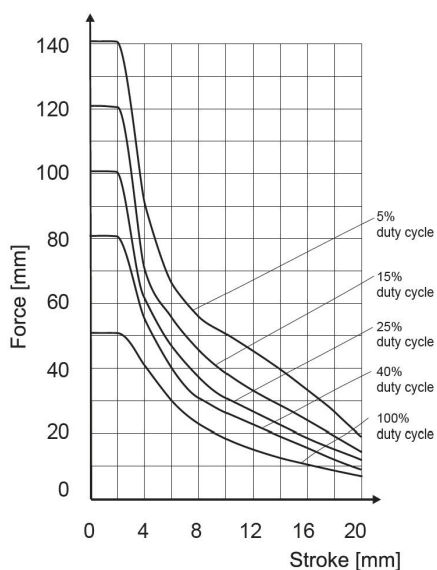

WL125

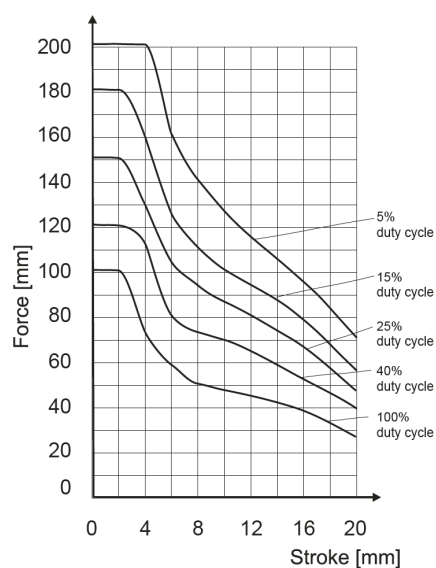

WL230

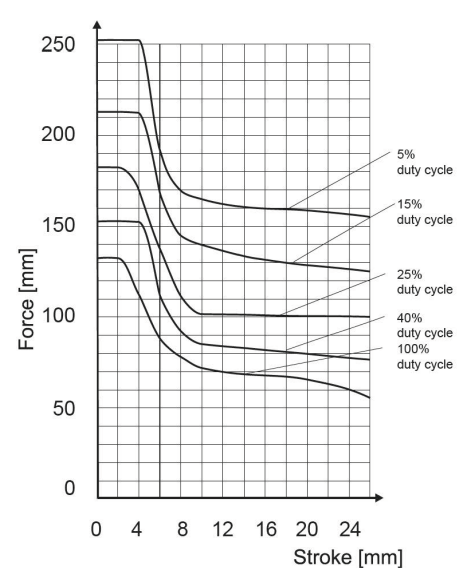

WL330

Special Models on Requeste

AC Solenoids Series WLG

Solenoid systems of the **series WLF** have the same design as the type series WL, but they are integrated into a closed aluminum housing providing special protection. This housing allows for particularly effective heat dissipation and use under relatively rough conditions.

WLF and WLG have the same design, the only difference being that a bellow ensures a high level of protection against dust.



AC Solenoids Series WLA

AC solenoids of the **series WLA** are particularly suitable for use under rough conditions. The excitation system is potted in the housing with casting resin. The cooling fins allow for particularly efficient heat dissipation. By means of the bellow and the standard connection via a box mounting receptacle the protection class IP65 is achieved here.



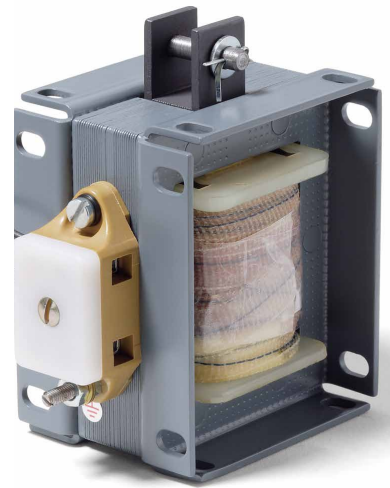

AC Solenoids Series WTI

With the **series WTI** the armature is I-shaped. The so-called plunger-principle is applied here, making this type particularly suitable for large strokes. The solenoid has a very strong acceleration as the stray field is narrow in the starting position. With the immersion of the armature the stray field can develop and the pulling force is reduced until the working air gap has narrowed accordingly. Due to this reduction the working flux dominates and increases the pulling force.

Further coil designs are available on request. With respect to the coil design higher forces can be achieved under consideration of a shorter duty cycle. Pushing models are also available on request. Here it has to be ensured that the force transfer is achieved by a non-magnetic stud.

Model

- 01, pulling with pull rod
- 04, pushing, with bore, without pull rod (on request)

Preferred Voltage

- 230 V / 50 Hz

Protection Class

- IP00, connection: IP20

EC Guidelines

- EC Machine guideline 2006/42/EC

Norms and Regulations

- Protection classes by housing VDE 0580
- Insulation class: B 130 VDE 0580/07.2000
- Electromagnetic devices and components EN 60529

Key for Type Designation and Order Example

WT I 05 01

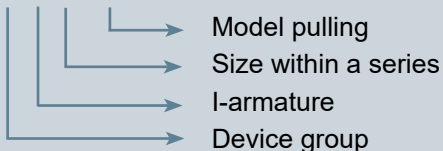

WTI0501

Model pulling,
230V, 50Hz, 100% Duty cycle, 30mm Stroke,
20 N stroke force

Cross Section

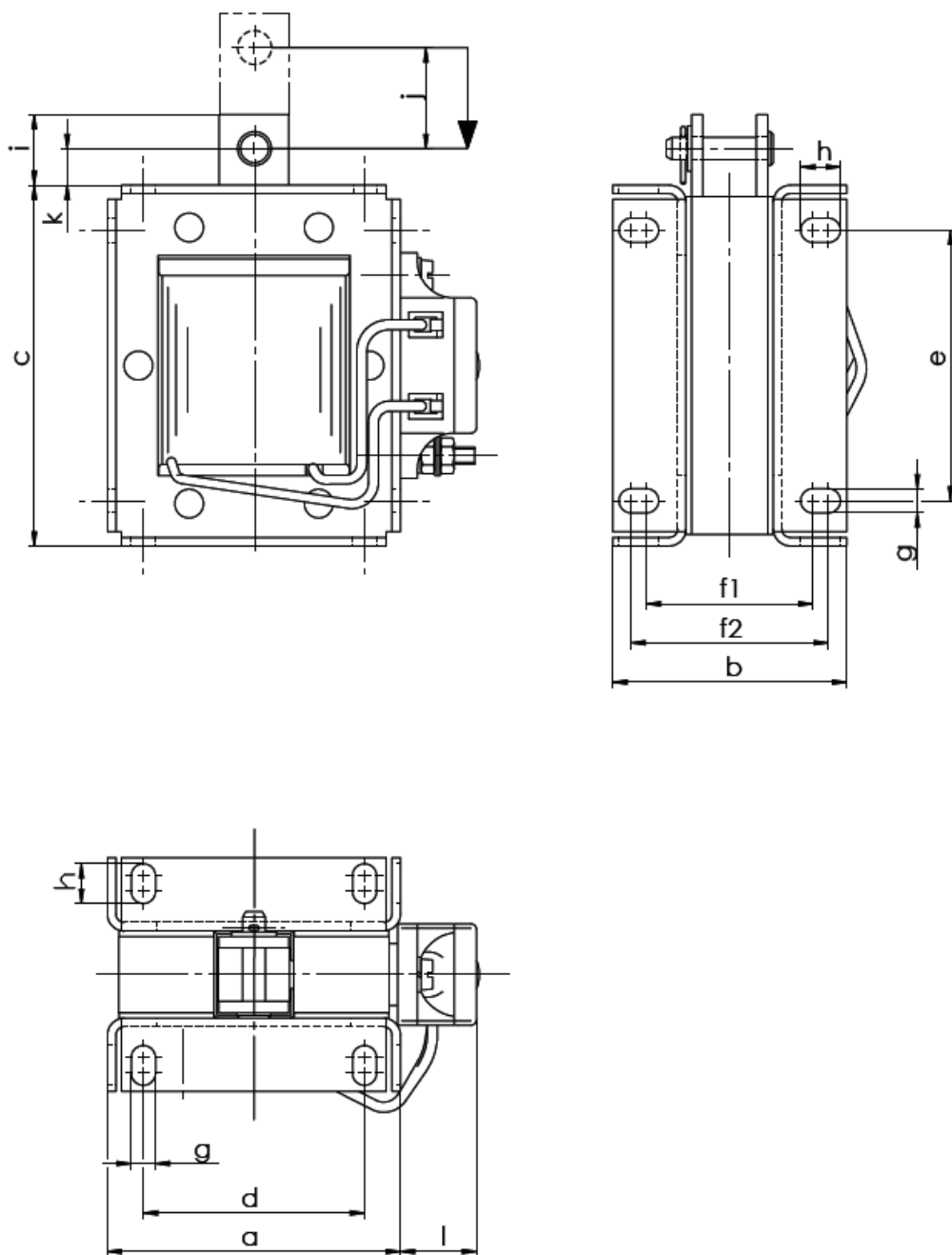

Dimensions in mm

Type	a	b	c	d	e	f1	f2	g	h	i	j (Stroke)	k	l
WTI02	44	40.5	52	34	42	30	35.5	3.2	8.7	14	20	7	13.5
WTI03	52	41.5	64	39.3	48	29.5	35	4.3	9.8	12.5	30	6.5	13.5
WTI04	52	52.5	64	39.3	48	40.5	46	4.3	9.8	17	30	9.3	13.5
WTI05	54	53	65	40	48	39.2	44.6	4.3	9.8	16.5	30	8.5	13.5
WTI06	63	44	76	45	60	29	33	4.3	8.3	18.5	40	11.5	14.5
WTI07	63	56	76	45	60	41	45	4.3	8.3	18.5	40	11.5	14.5
WTI08	63	61	76	45	60	46	50	4.3	8.3	18.5	40	10	15.0

Technical Data

Type	WTI02	WTI03	WTI04	WTI05	WTI06	WTI07	WTI08
Stroke (mm)	20	30	30	30	40	40	40
Duty cycle (%)	100	100	100	100	100	100	100
Initial force (N)	6.5	5	11	20	12	29	27
Appar. power stroke start (KVA)	0.196	0.35	0.45	0.68	0.65	0.8	1.02
End force (N)	31	35	50	78	45	62	72
Apparent power stroke end (KVA)	0.038	0.045	0.05	0.066	0.065	0.06	0.07
Pull-in time (ms) max. stroke	95	120	120	72	90	90	90
Release time (ms) max. stroke	80	95	95	72	90	90	90
Weight solenoid in kg	0.325	0.45	0.63	0.7	0.78	1.1	1.35
Weight armature in kg	0.07	0.07	0.125	0.13	0.1	0.18	0.22

Switching Frequency

Type	Stroke 0		Stroke 5		Stroke 10		Stroke 15		Stroke 20		Stroke 25		Stroke 30		Stroke 35		Stroke 40	
	N	KVA	N	KVA	N	KVA	N	KVA	N	KVA	N	KVA	N	KVA	N	KVA	N	KVA
WTI02	31.0	0.038	11.0	0.105	8.8	0.145	8.0	0.176	6.5	0.196	–	–	–	–	–	–	–	–
WTI03	35.0	0.045	13.5	0.140	11.0	0.190	11.0	0.230	11.0	0.290	10.0	0.315	5.0	0.350	–	–	–	–
WTI04	50.0	0.050	22.0	0.175	16.0	0.240	16.0	0.300	16.0	0.360	16.0	0.410	11.0	0.450	–	–	–	–
WTI05	78.0	0.066	23.0	0.230	20.0	0.320	20.0	0.400	20.0	0.500	20.0	0.600	20.0	0.680	–	–	–	–
WTI06	45.0	0.065	18.0	0.180	13.0	0.265	12.0	0.330	13.0	0.385	14.0	0.450	15.0	0.530	16.0	0.600	12.0	0.650
WTI07	62.0	0.060	30.0	0.180	22.0	0.300	22.0	0.360	23.0	0.450	25.0	0.550	27.0	0.660	28.0	0.730	29.0	0.800
WTI08	72.0	0.070	42.0	0.215	27.0	0.305	24.0	0.410	25.0	0.520	26.0	0.645	28.0	0.820	29.0	0.945	27.0	1.020

Highest switching frequency per hour (S/h) with design 100% DC

3600	1200	600	300
------	------	-----	-----

Stroke Force Characteristic Curves

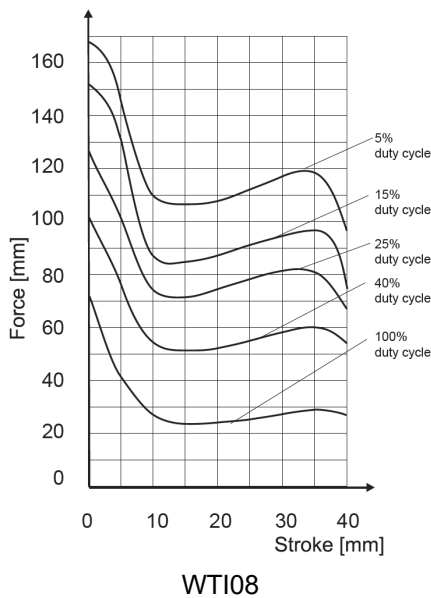
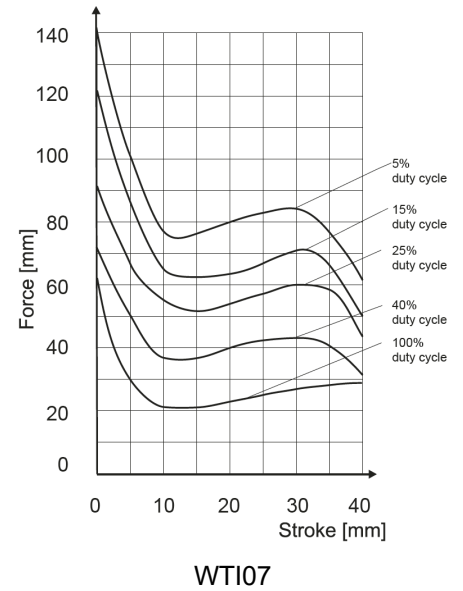
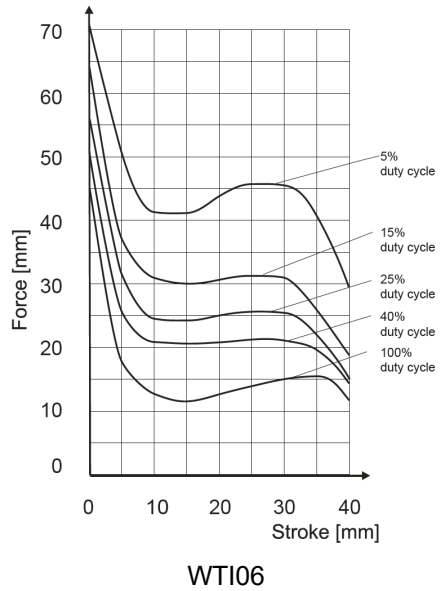
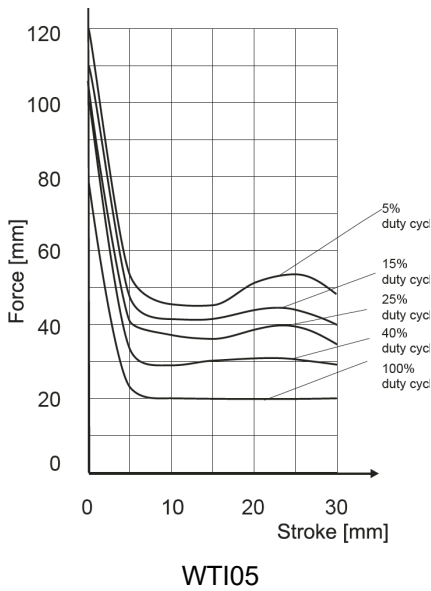
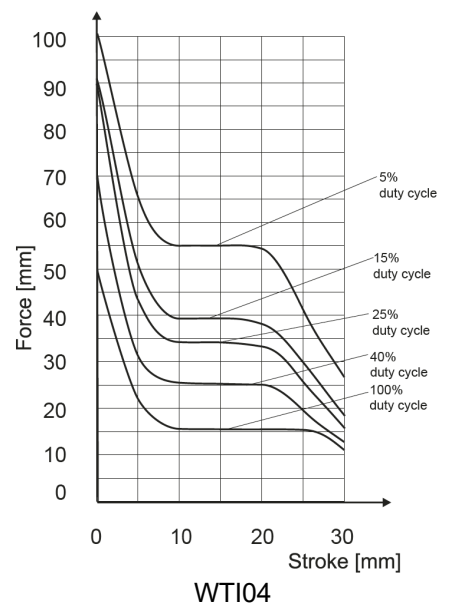
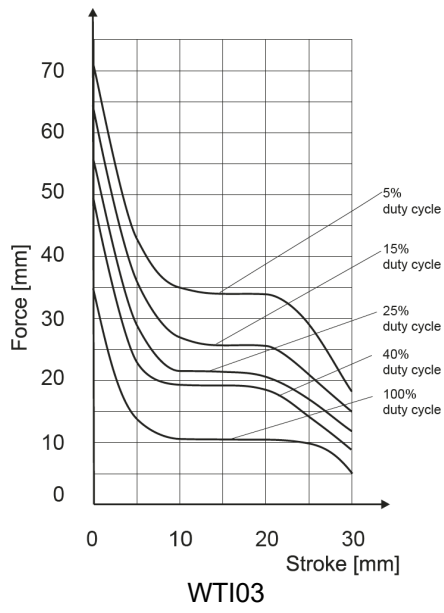
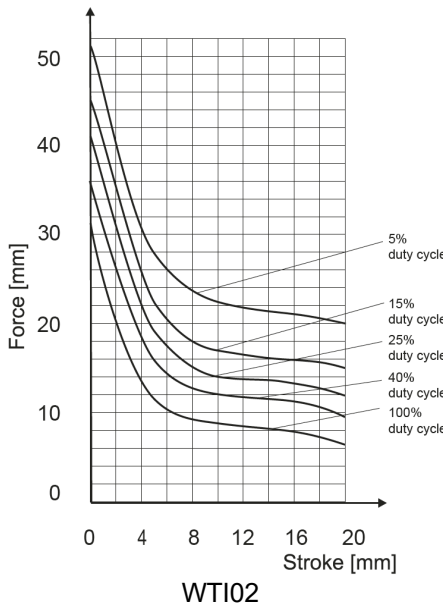

Thermal Classes

As shown in the table below thermal classes are classified according to DIN VDE 0580 / 07.2000 into insulation classes on the basis of their longterm thermal stability. Depending on the type our linear solenoids are manufactured in thermal classes E, B and F. If required by the application most devices can also be delivered in thermal class H.

Thermal class	Limit temperature °C	Limit overtemperature °C
Y	90	50
A	105	65
E	120	80
B	130	90
F	155	115
H	180	140

Protection Classes [IP]

Protection classes are indicated by a short symbol consisting of the two invariable code letters IP and two code letters for the degree of protection. The protection classes indicated are determined according to IEC 60529. They apply to protection against contact and against penetration of foreign substances. The second code letter applies to protection against penetration of water.

In case the protection class of e.g. the electrical connection deviates from that of the solenoid the protection class of the connection is indicated separately, e.g. housing IP 54, connection IP 00.

Code Letters Protection against contact and foreign substances	
0	no protection
1	protection against big foreign substances
2	protection against medium-sized foreign substances
3	protection against small foreign substances
4	protection against grain-shaped foreign substances
5	protection against dust deposit
6	protection against dust penetration

Code Letters Protection against water	
0	no protection
1	protection against vertical dripping water
2	protection against dripping water falling at an angle
3	protection against spray water
4	protection against splashing water
5	protection against flooding

Code Letters Protection against water	
6	protection against flooding
7	protection against immersion
8	protection against submersion

Rated Modes of Operation

Continuous operation is the operation during which the duty cycle is so long that the SteadyState temperature is reached.

Intermittent operation is the operation during which duty-cycle and currentless break alternate in regular and irregular intervals, the breaks being so short that the device cannot cool down to the reference temperature.

Short time operation is the operation during which the duty cycle is so short that the SteadyState time is not reached. The currentless break is so long that the solenoid cools down to the reference temperature.

Technical Terms Related to Electricity

The rated voltage (U_N) is the voltage with which the solenoid is operated in normal operation.

The rated power (P_N) is the power which results from the rated voltage and the rated current with DC solenoids of a coil temperature of 20°C.

The rated current (I_N) is the current which results from the rated voltage (U_N) and the resistance (R20) with a coil temperature of 20°C.

Technical Terms Related to Force

Magnetic force is the exploitable mechanical force reduced by the friction which is generated in stroke direction. The magnetic force is safely reached with 90% rated voltage and maximum warming. With rated voltage the listed values rise by approx. 20%.

Stroke force is the magnetic force which acts outside taking the respective component of armature weight into consideration.

Holding force is the magnetic force in stroke end position with DC-solenoids; with AC-solenoids it is the average value of the magnetic force periodically fluctuating with the alternating current in stroke end position.

Reset force is the force required to reset the armature into stroke start position after switching off the excitation current.

Relative duty cycle (% ED) is the ratio between duty cycle and cycle time in per cent. It is calculate according to the following formula:

$$\% ED = (\text{duty cycle} / \text{cycle time}) * 100$$

In order to calculate the relative duty cycle the preferred value of the cycle time acc. DIN VDE 0580 item 3.2.2 of 5 minutes is usually taken as a basis.

If the cycle time is irregular the relative duty cycle is determined from the ratio between the sum of the duty cycles and the sum of the cycle times over a longer period of operation.

The maximum values of the duty cycle must not be exceeded. If the relative duty cycle was determined and its value exceeds the permitted maximum value acc. DIN VDE the higher %-ED has to be selected into the range of which the duty cycle fits in. (Tables 1 and 2)

Playing time is the sum of the duty cycle and the currentless break. For DC single-stroke solenoids the playing time is max. 5 minutes = 300s. This equals 12 switchings / hour. The minimum playing time is limited by the actuation and release times in connection with the relative duty cycle. For a playing time of 300s there are maximum values for the duty cycle which must not be exceeded. In case the permitted duty cycle is exceeded a solenoid of the next higher relative duty cycle has to be selected.

If the duty cycle of 180s is exceeded the solenoid has to be selected for 100% duty cycle (continuous energization) or in special cases of the duty cycle calculated from the on/off ratio needs to be adapted by a proper selection of the magnetic coil. If the playing time is irregular the relative duty cycle is determined from the ratio between the added duty cycles and the added playing times over a longer **period of operation**.

By **playing sequence** we understand a single or periodically returning sequence of values for playing time.

Fuse Protection

Due to the differences in power consumption depending on the stroke an effective fuse protection of the AC solenoids is not possible. If some protection has to be provided please refer to the following formula:

$$I = \frac{\text{KVA open} \times 1000}{2 \times U} \quad [A]$$

A delayed fuse has to be used.

Frequency

Normally the coil is designed for a connection to 50 Hz. A solenoid with a rated frequency of 50 Hz may possibly be connected with the same voltage to a higher frequency. It has to be observed, however, that the magnetic force is reduced (appr. 30%). The use of a lower frequency is to be avoided as not only the force but also the heating increases (max. values 40 to 60 Hz). An adaptation to a lower frequency is possible on request, without a substantial modification of the magnetic forces specified in the list.

Relative duty cycle (% ED)	5	15	25	40	60	100
Permitted maximum duty cycle (s)	15	45	75	120	180	random

Table 1

Switching number (S / h)	12		120		300		600		1200		3000	
	300		30		12		6		3		1.2	
% ED	t _{on}	t _{off}	t _{on}	t _{off}	t _{on}	t _{off}	t _{on}	t _{off}	t _{on}	t _{off}	t _{on}	t _{off}
5	15	285	1.5	28.5	0.6	11.4	0.3	5.7	0.15	2.85	0.06	1.14
15	45	255	4.5	25.5	1.8	10.2	0.9	5.1	0.45	2.55	0.18	1.02
40	120	180	12.0	18.0	4.8	7.2	2.4	3.6	1.20	1.80	0.48	0.72
60	180	120	18.0	12.0	7.2	4.8	3.6	2.4	1.80	1.20	0.72	0.48
100	random											

Table 2

Overview of Catalogue



Classic Line

- single-stroke solenoids
- compact design
- individual fixing
- mono- and bistable version



High Performance Line

- square single-stroke solenoids
- high force with small installation space
- modular system
- short pull-in times



High Power Line

- round single-stroke solenoids
- high forces and stroke travels
- short switching times
- also reversible solenoids



Control Power Line

- control solenoids
- extremely fast
- switching
- short strokes
- precise switching



Hahn CQ^{Line}

- door holding magnet
- design and functionality
- VdS, CE, EN 1155,
- EN 14637 tested
- great variety



Industrial Line

- industrial holding magnets
- high holding force with low power consumption
- compact design
- variable connections



Oscillating Line

- vibratory solenoids
- wide product range for transportation of bulk material
- low wear
- compact design



Elevator Line

- spreader solenoids
- especially designed for elevator brakes
- extremely high forces
- any mounting position



ATEX Line

- explosion-proof solenoids
- prevent the occurrence of sparks and light arcs
- dynamic and reliable switching



Locking Line

- locking solenoids
- high transverse forces
- integrated feedback of locking function
- compact design



System Line

- operated by AC
- extremely short activation times
- very high pull-in forces

Custom Solutions

- **Rotary solenoids**
- **Assemblies**
- **Customer-specific solutions**

Please contact us for special or customer-specific solutions.

Kendrion Donaueschingen/Engelswies GmbH
 Industrial Magnetic Systems
 Sales Team Donaueschingen and Engelswies
 Tel.: +49 771 8009 3770
 Mail: sales-ims@kendrion.com



WE MAGNETISE THE WORLD

If you do not find what you are looking for, please feel free to contact us!
We will find the best solution for you.

Germany : Headquarters

Kendrion (Donaueschingen/Engelswies) GmbH
August-Fischbach-Straße 1
78166 Donaueschingen
Telefon: +49 771 8009 0
Telefax: +49 771 8009 3634
sales-ims@kendrion.com

Germany: Headquarters

Kendrion (Donaueschingen/Engelswies) GmbH
Hauptstraße 6
72514 Inzigkofen-Engelswies
Telefon: +49 7575 208 0
Telefax: +49 7575 208 3190
sales-ims@kendrion.com

For further contacts please refer to www.kendrion.com

